

# **CHIMEI INNOLUX DISPLAY CORPORATION**

## **LCD MODULE**

# **SPECIFICATION**

**Customer:** \_\_\_\_\_  
**Model Name:** AT056TN53 V.1  
**SPEC NO.:** A056-53-TT-11  
**Date:** 2010/04/06  
**Version:** 01

- Preliminary Specification  
 Final Specification

For Customer's Acceptance

Approved by	Comment

Approved by	Reviewed by	Prepared by
Hans Chen  2010/04/07	Charlie Chou James Yu  2010/04/07	David Lee  2010/04/06

## Record of Revision

Version	Revise Date	Page	Content
Pre-spec.01	2010/02/08		Initial Release
Final-spec.01	2010/04/06		The first version final specification
		1	Add the value of the backlight power consumption
		1	Add the value of the panel power consumption
		1	Add the value of weight
		6	Add the value of Current Consumption
		21	Update the value of LCM module & total weight

## Contents:

1.General Specifications .....	1
2.Pin Assignment .....	2
3.Operation Specifications .....	5
3.1. Absolute Maximum Ratings .....	5
3.2. Typical Operation Conditions .....	6
3.3. Power Sequence .....	7
3.4. Timing Characteristics .....	8
3.4.1. Timing Conditions .....	8
3.4.2. Timing Diagram .....	10
4. Optical Specifications .....	13
5. Reliability Test .....	17
6. General Precautions .....	18
6.1. Safety .....	18
6.2. Handling .....	18
6.3. Static Electricity .....	18
6.4. Storage .....	18
6.5. Cleaning .....	18
7. Mechanical Drawing .....	19
8. Package Drawing .....	20
.8.1. Packaging Material Table .....	20
.8.2. Packaging Quantity .....	20
8.3. Packaging Drawing .....	21

# 1.General Specifications

No.	Item	Specification	Remark
1	LCD size	5.6 inch(Diagonal)	
2	Driver element	a-Si TFT active matrix	
3	Resolution	640 × (RGB) × 480	
4	Display mode	Normally White, Transmissive	
5	Dot pitch	0.0588(W) × 0.1764(H) mm	
6	Active area	112.896 (W) × 84.672(H) mm	
7	Module size	126.5(W) × 100(H) × 5.7(D) mm	Note 1
8	Surface treatment	Anti-Glare	
9	Color arrangement	RGB-stripe	
10	Interface	Digital	
11	Backlight Power consumption	1.90W(Typ.)	Note 2
12	Panel Power consumption	0.66 W(Typ.)	Note 3
13	Weight	83.1g(Typ.)	

Note 1: Refer to Mechanical Drawing.

Note 2: Including LED Driver power consumption.

Note 3: Including T-con Board power consumption.

## 2.Pin Assignment

### TFT LCD Panel Driving Section

FPC connector is used for the module electronics interface. The recommended model is FH19-40S -0.5SH manufactured by HiRose.

Pin No.	Symbol	I/O	Function	Remark
1	V <sub>LED</sub>	P	Power Voltage for LED circuit	
2	V <sub>LED</sub>	P	Power Voltage for LED circuit	
3	ADJ	I	Adjust the LED brightness with PWM Pulse	Note1,2
4	G <sub>LED</sub>	P	Ground for LED circuit	
5	G <sub>LED</sub>	P	Ground for LED circuit	
6	V <sub>CC</sub>	P	Power Voltage for digital circuit	
7	V <sub>CC</sub>	P	Power Voltage for digital circuit	
8	MODE	I	DE or HV mode control	Note 3
9	DE	I	Data enable	
10	VS	I	Vsync signal input	
11	HS	I	Hsync signal input	
12	GND	P	Power ground	
13	B5	I	Blue data input (MSB)	
14	B4	I	Blue data input	
15	B3	I	Blue data input	
16	GND	P	Power ground	
17	B2	I	Blue data input	
18	B1	I	Blue data input	
19	B0	I	Blue data input(LSB)	
20	GND	P	Power ground	
21	G5	I	Green data input(MSB)	
22	G4	I	Green data input	
23	G3	I	Green data input	
24	GND	P	Power ground	
25	G2	I	Green data input	

26	G1	I	Green data input	
27	G0	I	Green data input(LSB)	
28	GND	P	Power ground	
29	R5	I	Red data input(MSB)	
30	R4	I	Red data input	
31	R3	I	Red data input	
32	GND	P	Power ground	
33	R2	I	Red data input	
34	R1	I	Red data input	
35	R0	I	Red data input(LSB)	
36	GND	P	Power ground	
37	DCLK	I	Sample clock	
38	GND	P	Power ground	
39	L/R	I	Select left to right scanning direction	Note4,5
40	U/D	I	Select up or down scanning direction	Note4,5

Note: I: input, O: output t, P: Power  
 Note1: Pin.3 is used to adjust brightness.

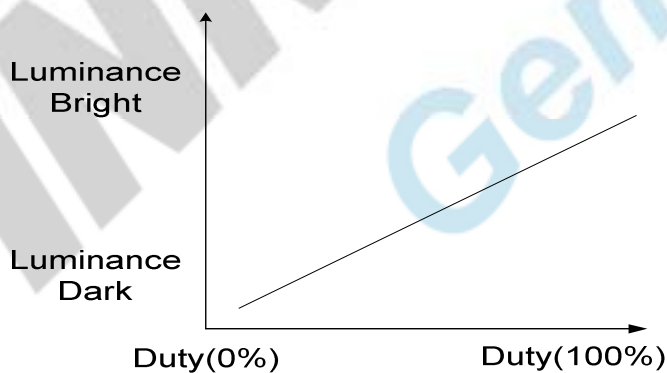

Note 2: ADJ signal=0~3.3V, operation frequency: 100~300Hz

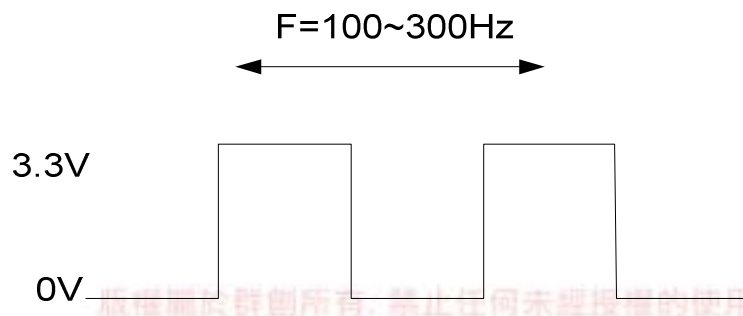

Note 3: DE Mode, Mode="H",HS floating and VS floating  
 HV Mode, Mode="L" and DE floating

Note 4: Selection of scanning mode

Setting of scan control input		Scanning direction
U/D	L/R	
GND	V <sub>CC</sub>	Up to down, left to right
V <sub>CC</sub>	GND	Down to up, right to left
GND	GND	Up to down, right to left
V <sub>CC</sub>	V <sub>CC</sub>	Down to up, left to right

Note 5: Definition of scanning direction.  
 Refer to the figure as below:

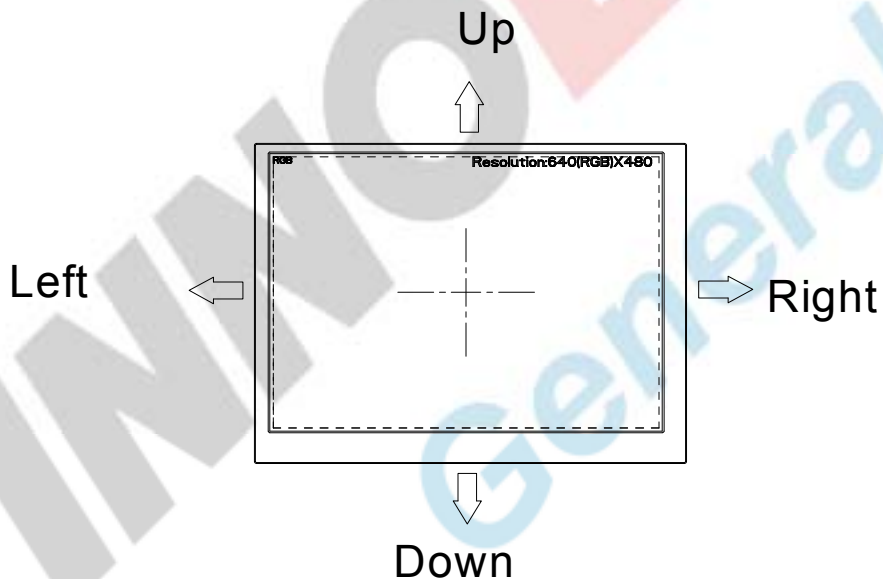

### 3.Operation Specifications

#### 3.1. Absolute Maximum Ratings

(Note 1)

Item	Symbol	Values		Unit	Remark
		Min.	Max.		
Power voltage	$V_{CC}$	-0.3	6.5	V	
	$V_{LED}$	-0.3	6.5	V	
Operation temperature	$T_{OP}$	-20	70	°C	
Storage temperature	$T_{ST}$	-30	80	°C	

Note 1: The absolute maximum rating values of the module should not be exceeded. Once exceeded absolute maximum rating values, the characteristics of the module may not be recovered. Even in an extreme condition, may result in module permanently destroyed.



### 3.2. Typical Operation Conditions

Item	Symbol	Values			Unit	Remark
		Min.	Typ.	Max.		
Power voltage	$V_{CC}$	3.1	3.3	3.5	V	Note 1
	$V_{LED}$	4.8	5.0	5.2	V	Note 2
Current Consumption	$I_{CC}$	-	200	250	mA	
	$I_{LED}$	-	380	450	mA	Note 3
Input logic high voltage	$V_{IH}$	$0.7V_{CC}$	-	$1V_{CC}$	V	Note 4
Input logic low voltage	$V_{IL}$	0	-	$0.3V_{CC}$	V	
LED life time	-	20,000	-	-	Hr	Note 5

Note 1:  $V_{CC}$  setting should match the signals output voltage (refer to Note 4) of customer's system board.

Note 2: LED driving voltage.

Note 3: LED driving current.

Note 4: DCLK, DE, HS, VS, R0~ R5,, G0~ G5, B0~ B5.

Note 5: The "LED life time" is defined as the module brightness decrease to 50% original brightness at  $T_a=25^{\circ}\text{C}$  and  $V_{LED}=5.0\text{V}$ . The LED lifetime could be decreased if operating  $V_{LED}$  is larger than 5.0V.

3.3.Power Sequence

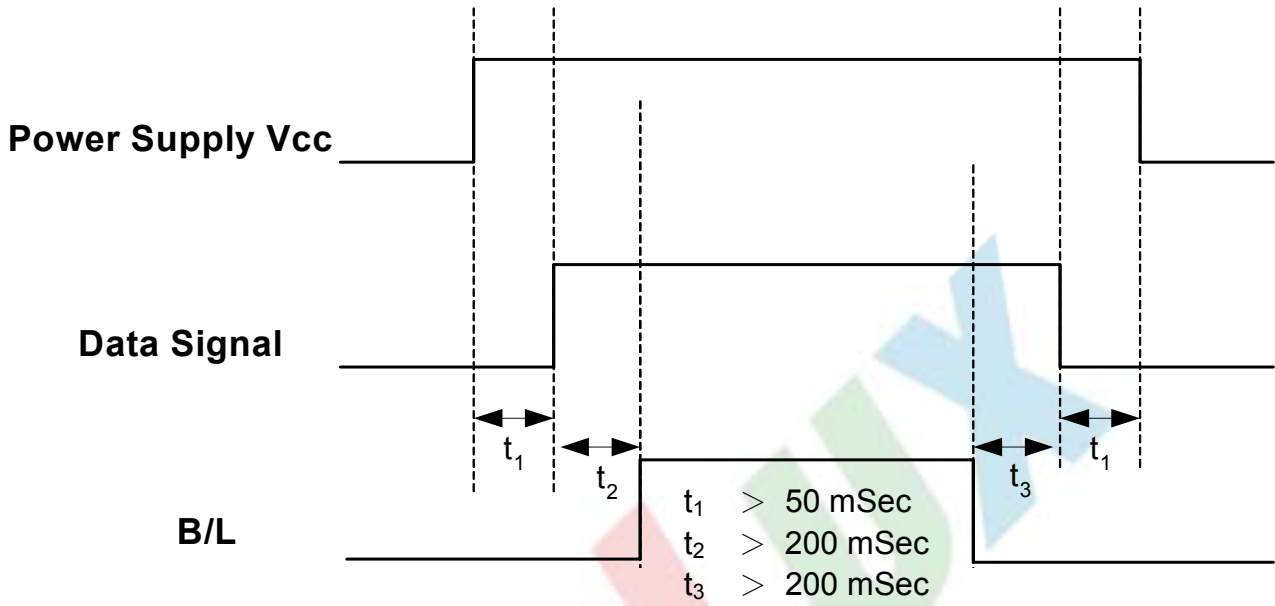

Note:Data includes DE, VS ,HS,B0~B5,G0~G5,R0~R5,DCLK.



### 3.4. Timing Characteristics

#### 3.4.1. Timing Conditions

Input/Output Timing

Item	Symbol	Values			Unit.	Remark
		Min.	Typ.	Max.		
PXLCLK clock time	Tclk	33.3	39.7	-	ns	
PXLCLK pulse duty	Tcwh	40	50	60	%	Tclk
DATA set-up time	Tdsu	12	-	-	ns	DATA to PXLCLK
DATA hold time	Tdhd	12	-	-	ns	DATA to PXLCLK
DE setup time	Tesu	12	-	-	ns	DE to PXLCLK
VSYNC setup time	Tvst	12	-	-	ns	
VSYNC hold time	Tvhd	12	-	-	ns	
HSYNC setup time	Thst	12	-	-	ns	
HSYNC hold time	Thhd	12	-	-	ns	
HSYNC period time	Th	22.91	31.76	-	us	
HSYNC width	Thwh	1	-	-	Tclk	
VSYNC width	Tvwh	1	-	-	Th	
HSYNC to CLKIN	Thc	-	-	1	Tclk	

DE Mode input Timing Limitation

DE Mode	Values			Unit	Remark
	Min.	Typ.	Max.		
THC	48	160	765	tclk	
THD	640	640	640	tclk	
TH	688	800	1405	tclk	1TH=1line
TVC	6	45	255	line	
TVD	480	480	480	line	
TV	486	525	735	line	1TV=1field

版權屬於群創所有，禁止任何未經授權的使用

The copyright belongs to CHIMEI INNOLUX. Any unauthorized use is prohibited.

HV Mode input Timing Limitation

HV Mode	Values			Unit	Remark
	Min.	Typ.	Max.		
Thwh	-	10	-	tclk	
Thbp	-	134	-	tclk	
Thfp	-	16	-	tclk	
THD	-	640	-	tclk	
TH	-	800	-	tclk	1TH=1 line
Tvwh	-	2	-	line	
Tvbp	-	11	-	line	
Tvfp	-	32	-	line	
TVD	-	480	-	line	
TV	-	525	-	line	1TV=1 field

3.4.2. Timing Diagram

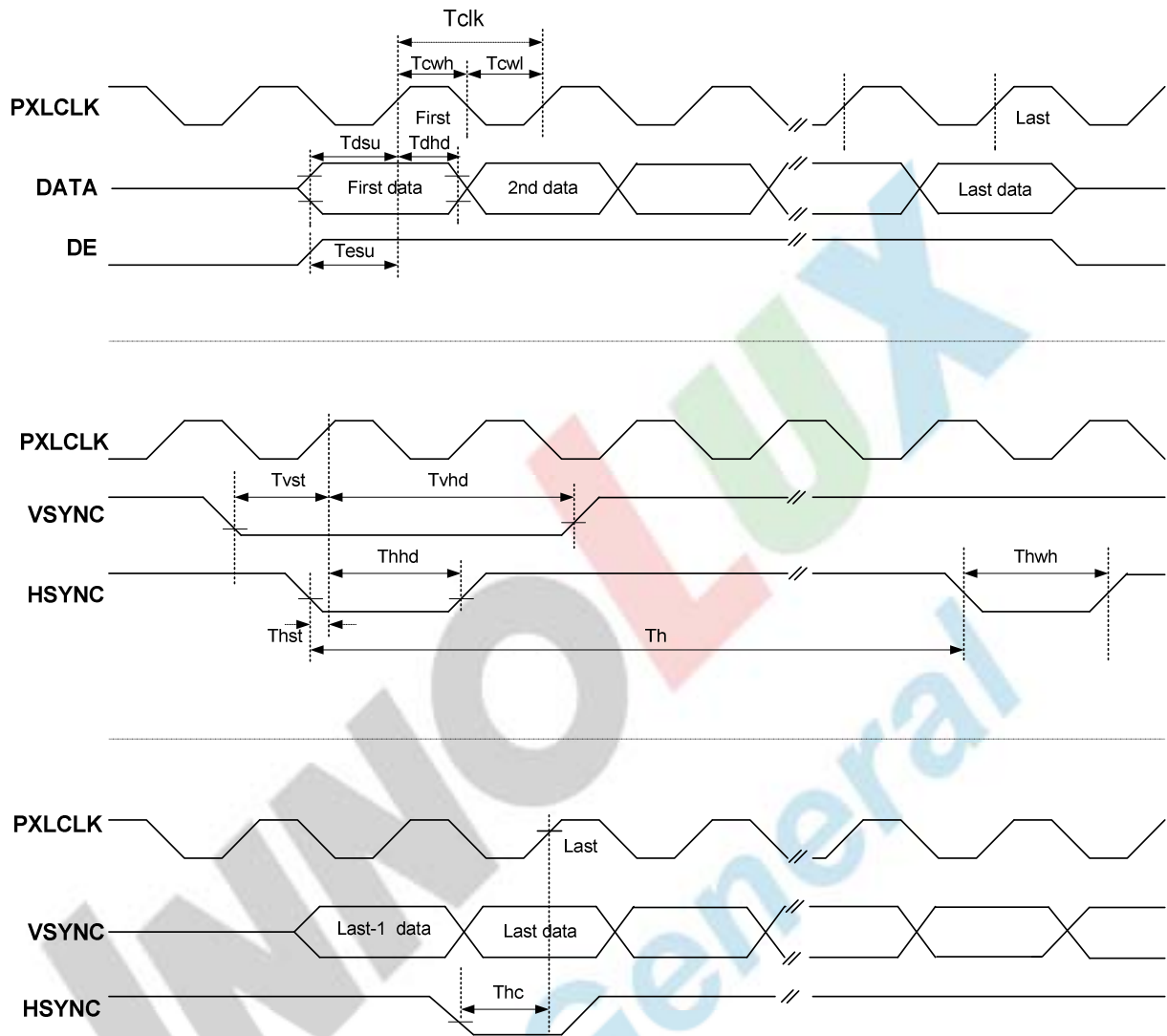

Fig.3-1 Clock and Data Input Timing Diagram

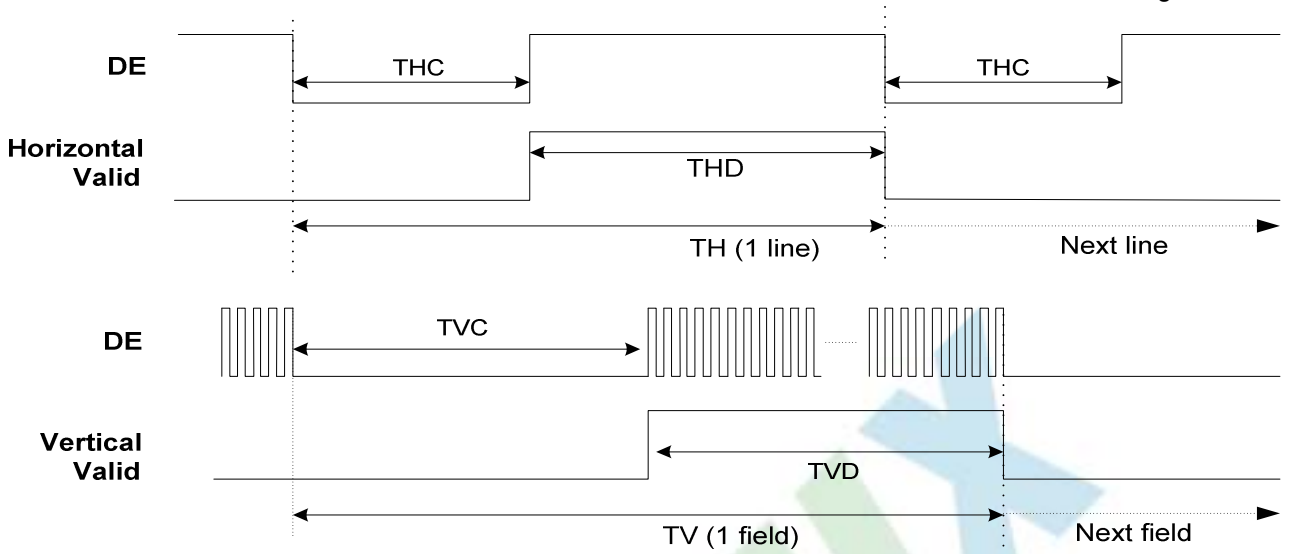

Fig.3-2 DE Mode Input Timing

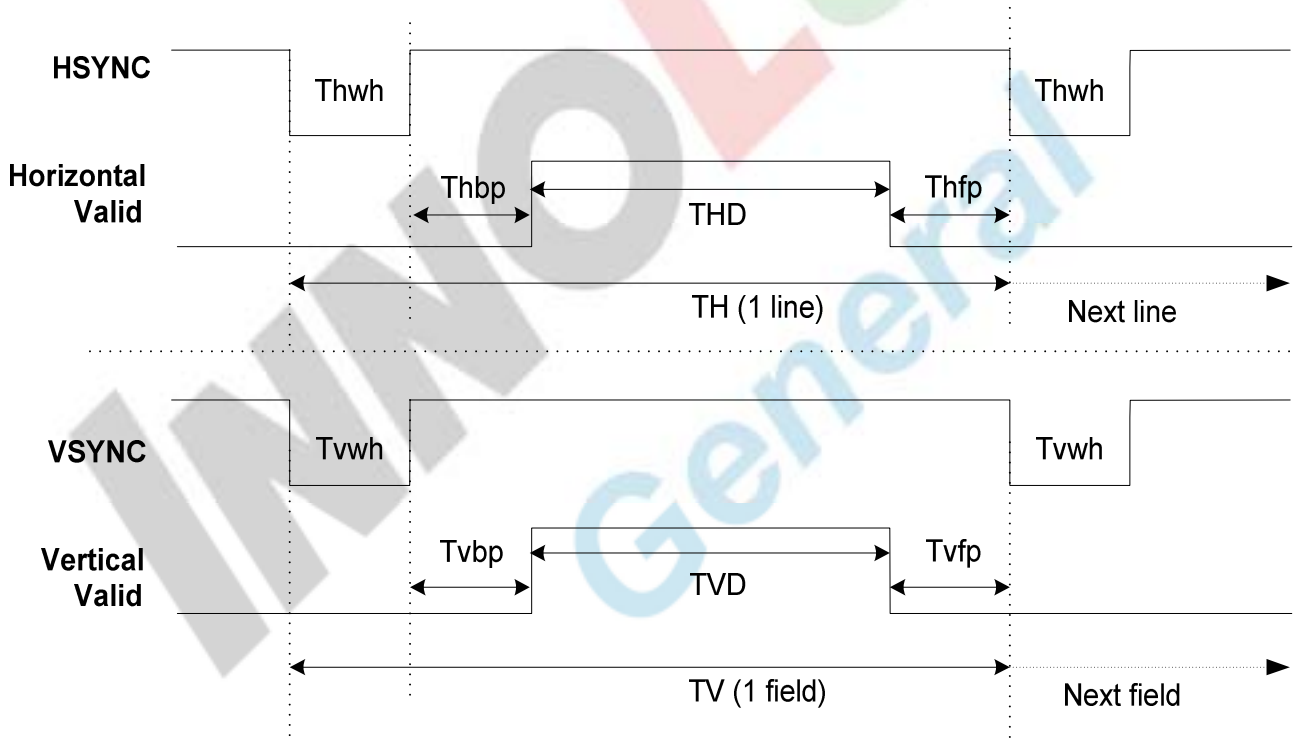

Fig.3-3 HV Mode Input Timing

版權屬於群創所有，禁止任何未經授權的使用

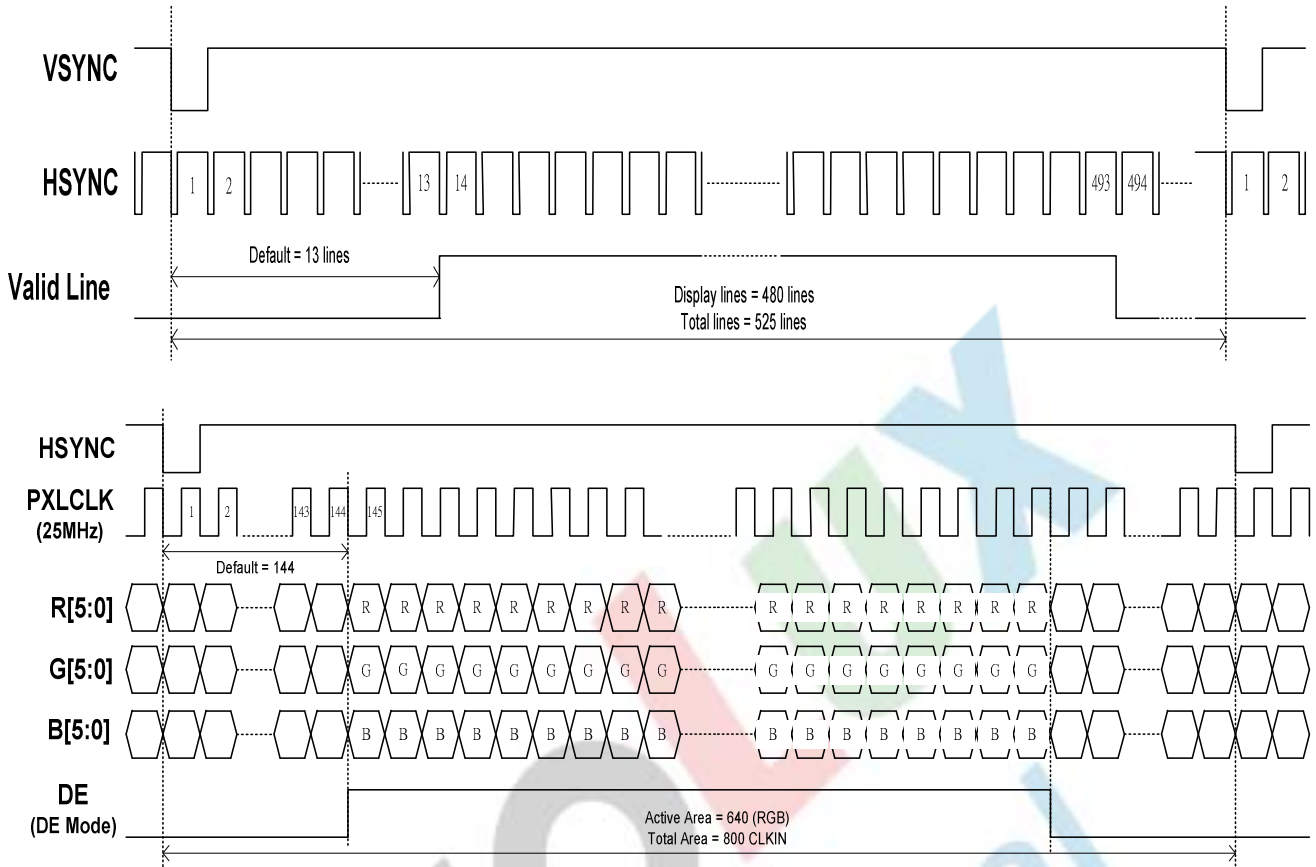

Fig. 3-4 18 bit RGB mode for 640 x (RGB) x 480

## 4. Optical Specifications

Item	Symbol	Condition	Values			Unit	Remark
			Min.	Typ.	Max.		
Viewing angle (CR≥10)	$\theta_L$	$\Phi=180^\circ$ (9 o'clock)	60	70	-	degree	Note 1
	$\theta_R$	$\Phi=0^\circ$ (3 o'clock)	60	70	-		
	$\theta_T$	$\Phi=90^\circ$ (12 o'clock)	40	50	-		
	$\theta_B$	$\Phi=270^\circ$ (6 o'clock)	60	70	-		
Response time	$T_{ON}$	Normal $\theta=\Phi=0^\circ$	-	10	20	msec	Note 3
	$T_{OFF}$		-	15	30	msec	Note 3
Contrast ratio	CR		400	500	-	-	Note 4
Color chromaticity	$W_X$		0.26	0.31	0.36	-	Note 2 Note 5 Note 6
	$W_Y$		0.28	0.33	0.38	-	
Luminance	$L_1$		280	350	-	cd/m <sup>2</sup>	Note 6
Luminance uniformity	$Y_U$		70	75	-	%	Note 6,7

Test Conditions:

1.  $V_{CC}=3.3V$ ,  $V_{LED}=5.0V$ , the ambient temperature is  $25^\circ C$ .
2. The test systems refer to Note 2.



Note 1: Definition of viewing angle range

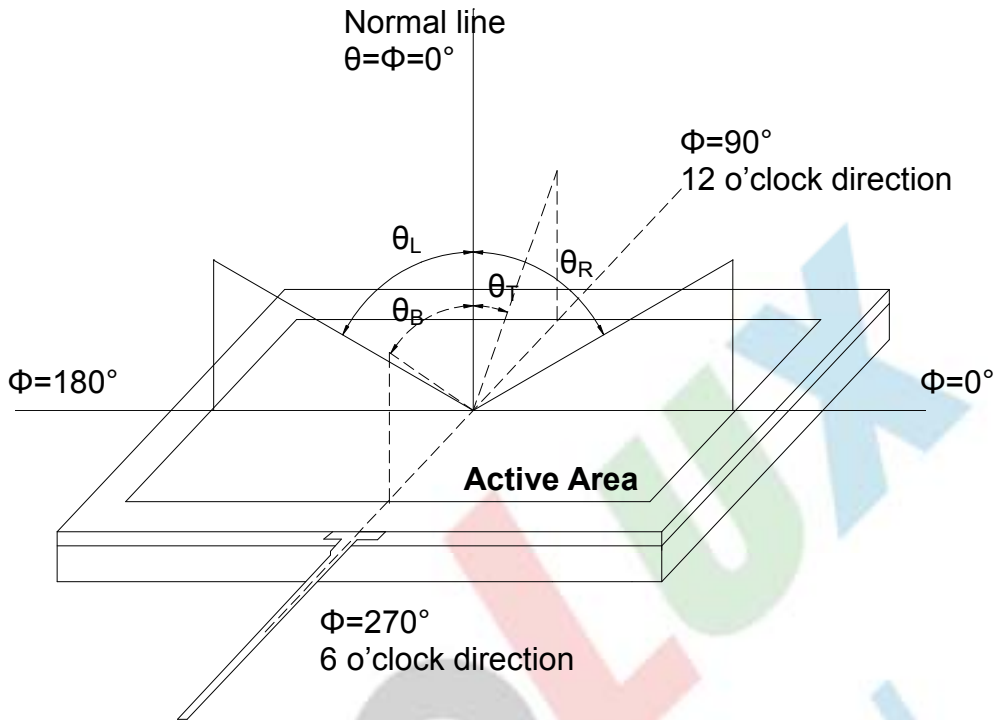

Fig. 4-1 Definition of viewing angle

Note 2: Definition of optical measurement system.

The optical characteristics should be measured in dark room. After 30 minutes operation, the optical properties are measured at the center point of the LCD screen. (Response time is measured by Photo detector TOPCON BM-7, other items are measured by BM-5A/Field of view:  $1^\circ$  /Height: 500mm.)

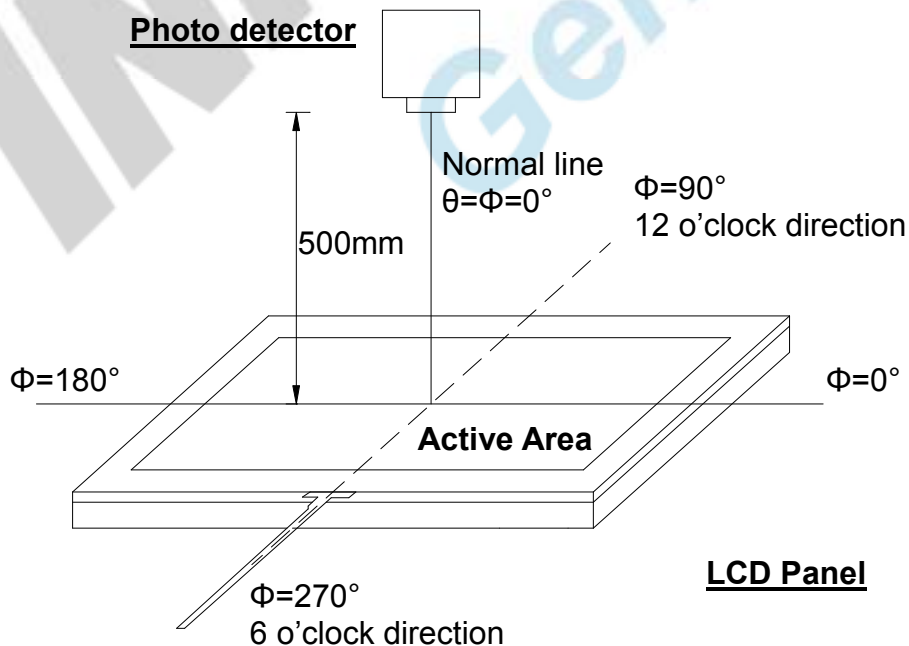

Fig. 4-2 Optical measurement system setup

Note 3: Definition of Response time

The response time is defined as the LCD optical switching time interval between "White" state and "Black" state. Rise time ( $T_{ON}$ ) is the time between photo detector output intensity changed from 90% to 10%. And fall time ( $T_{OFF}$ ) is the time between photo detector output intensity changed from 10% to 90%.

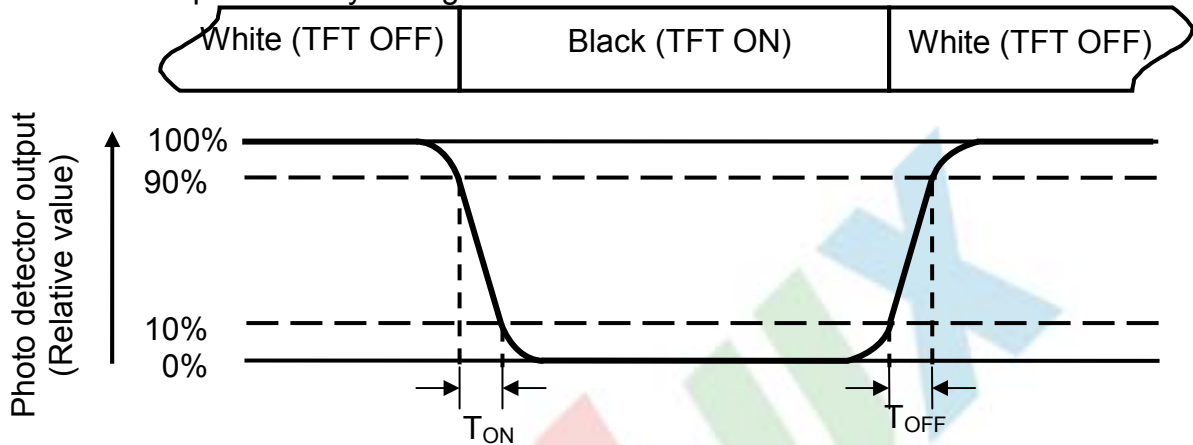

Fig. 4-3 Definition of response time

Note 4: Definition of contrast ratio

$$\text{Contrast ratio (CR)} = \frac{\text{Luminance measured when LCD is on the "White" state}}{\text{Luminance measured when LCD is on the "Black" state}}$$

Note 5: Definition of color chromaticity (CIE1931)

Color coordinates measured at center point of LCD.

Note 6: All input terminals LCD panel must be ground while measuring the center area of the panel. The LED driving condition is  $V_{LED}=5.0V$

Note 7: Definition of Luminance Uniformity

Active area is divided into 9 measuring areas (Refer to Fig. 4-4 ).Every measuring point is placed at the center of each measuring area.

$$\text{Luminance Uniformity (Yu)} = \frac{B_{min}}{B_{max}}$$

L-----Active area length      W----- Active area width

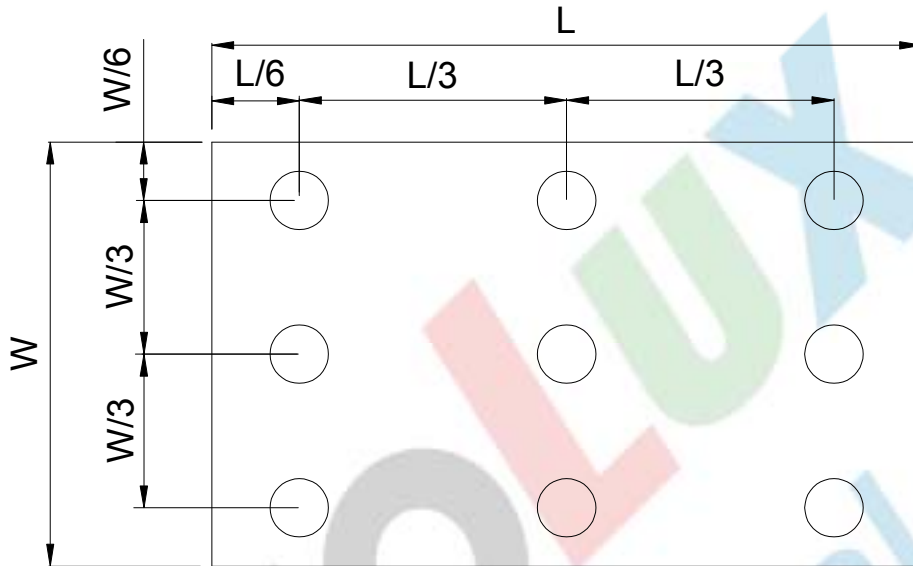

Fig. 4-4 Definition of measuring points

**B<sub>max</sub>**: The measured maximum luminance of all measurement position.  
**B<sub>min</sub>**: The measured minimum luminance of all measurement position.

## 5. Reliability Test

(Note3)

Item	Test Conditions	Remark
High Temperature Storage	Ta = 80°C                      240 hrs	Note 1, 4
Low Temperature Storage	Ta = -30°C                      240hrs	Note 1,4
High Temperature Operation	Ts = 70°C                      240hrs	Note 2,4
Low Temperature Operation	Ta = -20°C                      240hrs	Note 1,4
Operate at High Temperature and Humidity	+40°C, 90%RH                      240 hrs	Note 4
Thermal Shock	-30°C/30 min ~ +80°C/30 min for a total 100 cycles, Start with cold temperature and end with high temperature	Note 4
Vibration Test	Frequency range:10~55Hz Stroke:1.5mm Sweep:10Hz~55Hz~10Hz 2 hours for each direction of X. Y. Z. (6 hours for total)	
Mechanical Shock	100G 6ms,±X, ±Y, ±Z 3 times for each direction	
Package Vibration Test	Random Vibration : 0.015G*G/Hz from 5-200HZ, -6dB/Octave from 200-500HZ 2 hours for each direction of X. Y. Z. (6 hours for total)	
Package Drop Test	Height:60 cm 1 corner, 3 edges, 6 surfaces	
Electro Static Discharge	± 2KV, Human Body Mode, 100pF/1500Ω	

Note 1: Ta is the ambient temperature of samples.

Note 2: Ts is the temperature of panel's surface.

Note 3: In the standard condition, there shall be no practical problem that may affect the display function. After the reliability test, the product only guarantees operation, but doesn't guarantee all the cosmetic specification.

Note 4: Before cosmetic and function tests , the product must have enough recovery time, at least 2 hours at room temperature.

## 6. General Precautions

### 6.1. Safety

Liquid crystal is poisonous. Do not put it in your mouth. If liquid crystal touches your skin or clothes, wash it off immediately by using soap and water.

### 6.2. Handling

1. The LCD panel is plate glass. Do not subject the panel to mechanical shock or to excessive force on its surface.
2. The polarizer attached to the display is easily damaged. Please handle it carefully to avoid scratch or other damages.
3. To avoid contamination on the display surface, do not touch the module surface with bare hands.
4. Keep a space so that the LCD panels do not touch other components.
5. Put cover board such as acrylic board on the surface of LCD panel to protect panel from damages.
6. Transparent electrodes may be disconnected if you use the LCD panel under environmental conditions where the condensation of dew occurs.
7. Do not leave module in direct sunlight to avoid malfunction of the ICs.

### 6.3. Static Electricity

1. Be sure to ground module before turning on power or operating module.
2. Do not apply voltage which exceeds the absolute maximum rating value.

### 6.4. Storage

1. Store the module in a dark room where must keep at  $+25\pm 10^{\circ}\text{C}$  and 65%RH or less.
2. Do not store the module in surroundings containing organic solvent or corrosive gas.
3. Store the module in an anti-electrostatic container or bag.

### 6.5. Cleaning

1. Do not wipe the polarizer with dry cloth. It might cause scratch.
2. Only use a soft sloth with IPA to wipe the polarizer, other chemicals might permanent damage to the polarizer.

7.Mechanical Drawing

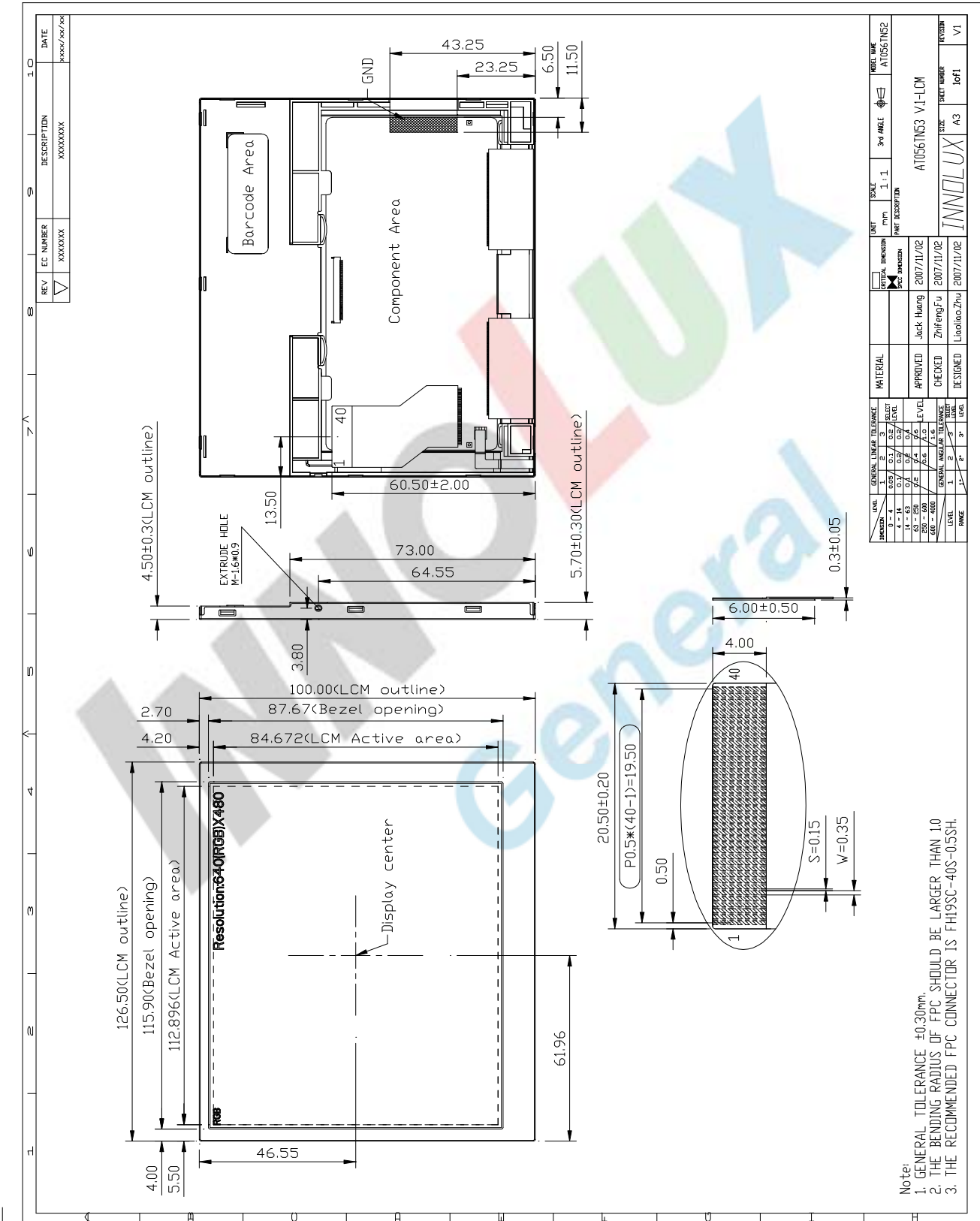

版權屬於群創所有，禁止任何未經授權的使用

## 8.Package Drawing

### .8.1.Packaging Material Table

No.	Item	Model (Material)	Dimensions(mm)	Unit Weight (kg)	Quantity	Remark
1	LCM Module	AT056TN53 V.1	126.5 × 100 × 5.7	0.083	60pcs	
2	Partition	B Corrugated paper	105 × 349	0.020	8pcs	
3	Corrugated Board	B Corrugated paper	510 × 350	0.144	2pcs	
4	Partition Paper	BC Corrugated paper	512 × 226 × 349	1.170	1set	
5	Dust-Proof Bag	PE	700 × 530	0.060	1pcs	
6	A/S Bag	PE	170 × 110 × 0.2	0.002	60pcs	
7	Carton	Corrugated paper	530 × 355 × 255	1.100	1 pcs	
8	Total Weight	7.878kg±5%				

### .8.2.Packaging Quantity

Total LCM quantity in Carton: no. of Partition	4 Rows x quantity per Row 15= 60
--	----------------------------------

8.3.Packaging Drawing

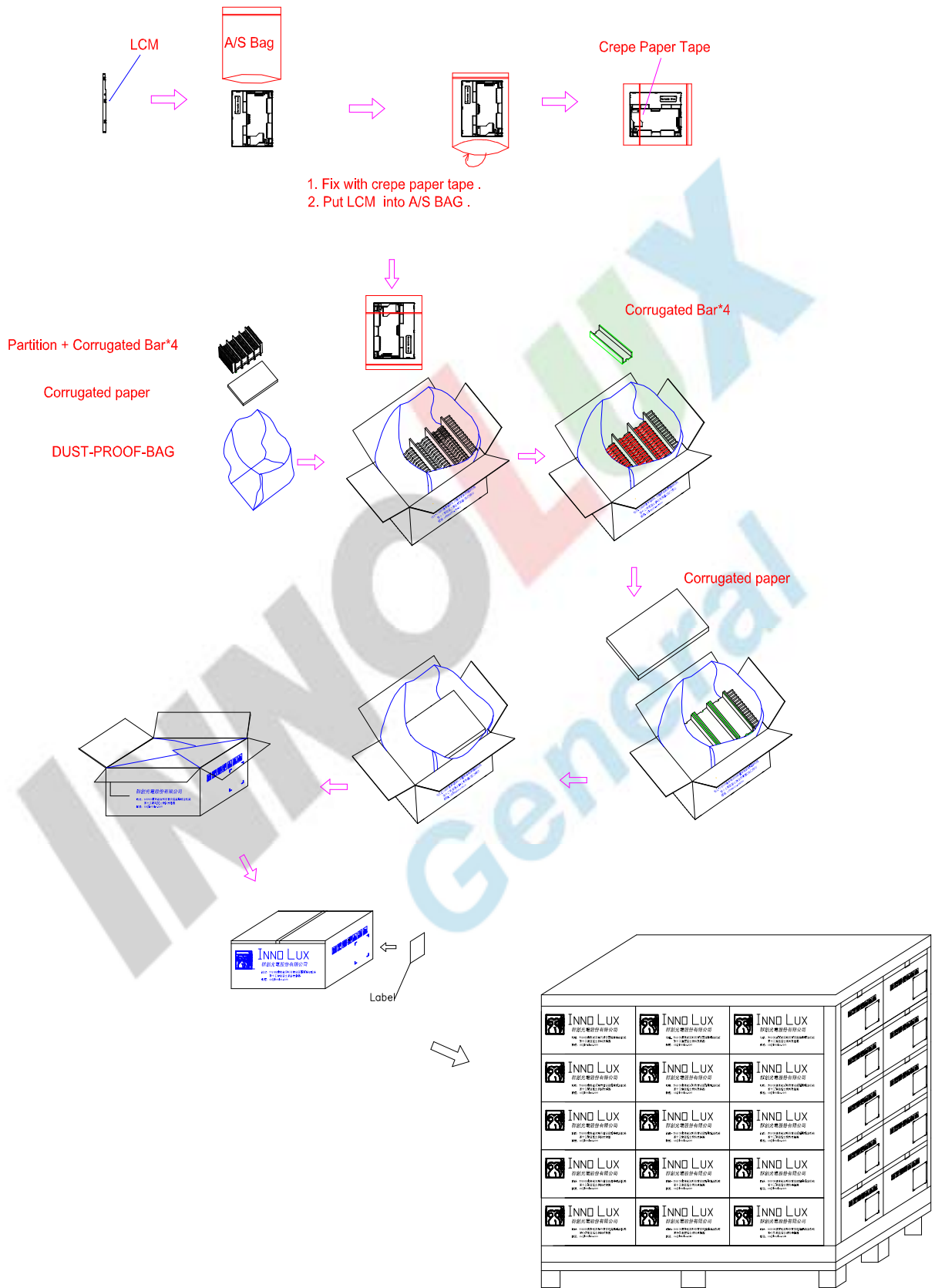

版權屬於群創所有，禁止任何未經授權的使用

The copyright belongs to CHIMEI INNOLUX. Any unauthorized use is prohibited.